

Chapter 7: Equilibrium

How to reach equilibrium

- 1) Closed system - if open, ^{matter exchanged with surroundings} some of the products/reactants could escape, hence no equilibrium
- 2) No observable change in concentration of products or reactants
- 3) Rate of forwards reaction = rate of backwards reaction

Dynamic Equilibrium: A point at which the rates of the forwards and backwards reactions are equal and there is no observable change in the concentration of the reactants or products

Dynamic: because forwards and backwards reactions actively occur

At equilibrium, there is no change in macroscopic properties, as these properties vary with reactant and product concentration and they do not change at equilibrium.

Microscopic Level [Rate]

- forwards reaction starts fast but rate decreases over time, due to less reactants being available as time passes
- Backwards starts at 0 as the reactants of the forwards have not been made yet, more of them available over time, hence rate increases

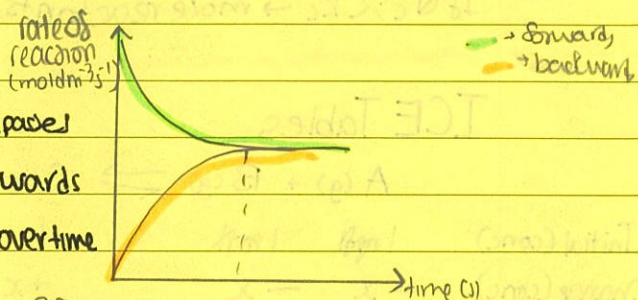

- When R of forwards and backwards are equal, the equilibrium reached

[Concentration]

- Conc of reactants decreases over time because they are being used in forwards
- Rate of decrease gets lower because of lower rate
- When conc of either reactants or products stay constant, the rates must be equal

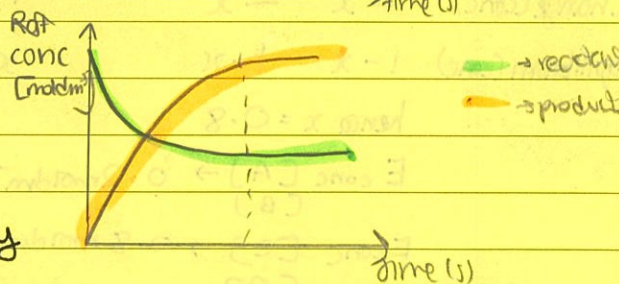

Equilibrium Constant [K_c] and Reaction Quotient

K_c (constant)

- fixed value for a reaction for a certain temp [T]
- Not influenced by initial concentration
- increases over time as ↑ [products] and ↓ [reactants]

~~If $K_c < 1$, reactants favoured (backwards)~~
~~If $K_c = 1$, same number of reactants as products~~
~~If $K_c > 1$, backwards reaction favoured~~

$K_c > 1$, products more than reactants

$K_c = 1$: Same-same

$K_c < 1$, reactants more than products

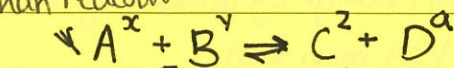

$$K_c = \frac{[C]^z [D]^a}{[A]^x [B]^y} \rightarrow \text{but conc must be at equilibrium}$$

\rightarrow reciprocal of K_c is K_c for backwards reaction

K_c trends

- If the forwards reaction is endothermic, K_c increases as temperature does
- If it is exo, K_c decreases as temperature does increases

Reaction Quotient

- A measure of the relative amounts of products and reactants present during a reaction at a particular point

NOTE: For homogenous reactions (all prods + reactants same state), include everything in the rate expression. For heterogenous (varied states), only include gases

If $Q_c > K_c \rightarrow$ more products, hence backwards favoured

If $Q_c < K_c \rightarrow$ more reactants, hence forwards favoured

ICE Tables



Initial (conc)	1 mol	1 mol	1	1
Change (conc)	-x	-x	+x	+x
Equilibrium (conc)	1-x	1-x	x	x

hence $x = 0.8$

E conc $[A]$ $\rightarrow 0.2 \text{ mol dm}^{-3}$

E conc $[C]$ $\rightarrow 0.8 \text{ mol dm}^{-3}$

information

- at equilibrium there are 0.2 mol dm^{-3} of A

$$1 - 0.2 = 0.8$$

$$\therefore K_c = \frac{[0.8][0.8]}{[0.2][0.2]}$$

$$= \frac{0.064}{0.04}$$

K_c tips

- 1) If multiple elementary steps, multiply all their K_c s together to find K_c for the overall reaction
- 2) Reciprocal of K_c is the K_c of reverse reaction

$$K_c = \underline{\underline{16}}$$

Factors affecting Equilibrium

- 1) Concentration



$$K_c = \frac{[C][D]}{[A][B]}$$

- If $[A] \uparrow$, the reaction counteracts the change by favouring the products, using up the added concentration and creating more products
- If $[A] \downarrow$ the reaction counteracts the change by favouring the reactants, making more A to replenish what had been lost

OR

- Look at K_c , is $[A] \uparrow$, $K_c \downarrow$, and the lower it is, the more the forwards reaction is favoured
- Is $[C] \uparrow$, $K_c \uparrow$, the higher it is, the more the backwards reaction is favoured

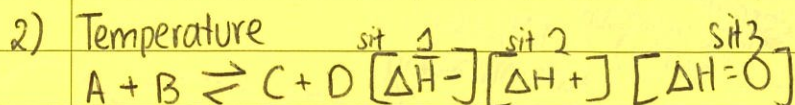

- In Situation 1, increasing the temperature favours the backwards reaction as that reaction is endothermic and absorbs the added heat, counteracting the change in temperature
- In situation 2, increasing the temperature favours the forwards reaction as it is endothermic and absorbs the heat added, counteracting the change
- In sit 3, change in temperature does not affect equilibrium

3) Pressure

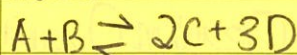

- Increasing pressure shifts the equilibrium ~~with~~ ^{to the} side that has the least gas molecules [favouring the reaction that produces it] because with fewer gas molecules, less force is applied on nearby surfaces, counteracting the change by reducing pressure
- If both sides have the same number of gas molecules, then changes in pressure do not affect the position of equilibrium

Terms to know and things about them

- 1) % yield - $\frac{\text{real}}{\text{theoretical}}$ → if this needs to be increased, exclude ~~pre~~ concentration
- 2) Shift to right / left → whatever is on that side is produced to a greater extent
- 3) ↑ Volume → ↓ pressure, VICEVERSA

NOTE: A catalyst only decreases E_a , it does not affect equilibrium or K_c but speeds up the forwards + backwards reactions to equal extents

Condition Change	System Change	Explanation
↑ P	↓ P	equilibrium shifts to side with least gas molecules, reducing pressure by reducing the number of particles colliding with surface
↑ T	↓ T	equilibrium shifts to products if endothermic as endothermic takes in heat released
↑ [A]	↓ [A]	Reaction uses up added A and hence produces more of the other side, shifting equilibrium there

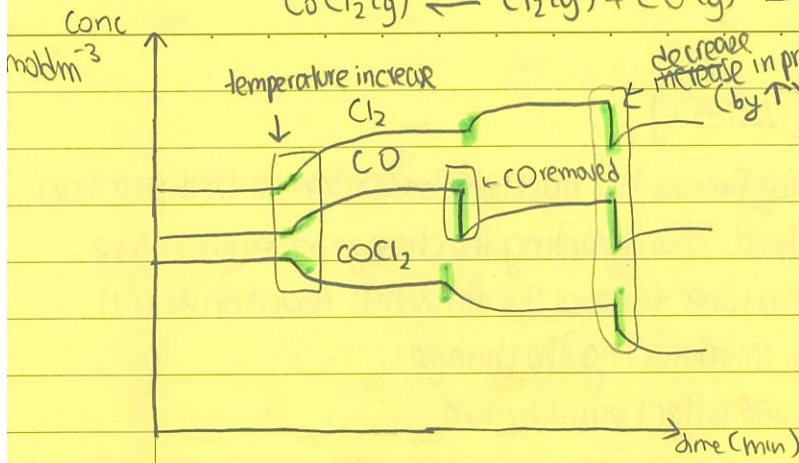
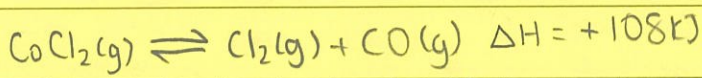

Why don't we use optimal conditions?

- 1) R_{f} too low (e.g. Haber)
- 2) Too expensive to create desired high pressure, expensive reinforced pipes needed

Note that when $K_c \rightleftharpoons 0$, $[\text{reactant}]_{\text{initial}}$ is the same as $[\text{reactant}]_{\text{equilibrium}}$

ΔG and Equilibrium

Recap

- $\Delta G = \Delta H - T\Delta S$
- $\Delta G = G_{\text{prod}} - G_{\text{reactants}}$

$$\Delta G = -RT \ln K_c$$

convert to $0.00831 \text{ kJ mol}^{-1} \text{ K}^{-1}$

If ΔG of forward reaction is $-ve$, forward reaction favoured as reverse must be $+ve$. Equilibrium is when ΔG is minimized and ΔS is maximised, hence when

$$\Delta G = 0$$

Summary of relationships

ΔG	K_c	$\ln K$	Mixture
$-ve$	$K_c > 1$	$\ln K = +ve$	more product
$+ve$	$K_c < 1$	$\ln K = -ve$	more reactant
0	$K_c = 1$	$\ln K = 0$	Equal quantities

Kinetics and Equilibrium

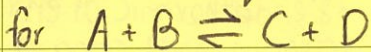

$$\text{Rate (forward)} = k[A][B]$$

$$\text{Rate (backward)} = k'[C][D]$$

} assuming overall order = 2

at equil

$$k[A][B] = k'[C][D]$$

$$\frac{k}{k'} = \frac{[C][D]}{[A][B]} = K_c$$

$\frac{k}{k'} = K_c \rightarrow$ This explains why a catalyst does not affect K_c , as k and k' are multiplied by the same factor that is canceled out ($k_c = \frac{k(x)}{k'(x)}$)

Furthermore, conc does not affect K_c as it does not affect k or k' .

Additionally, temperature affects K_c because of $k = F A e^{-\frac{E_a}{RT}}$. Hence each k increases with T , but each constant is affected differently than the other. For an endo, $K_c \uparrow$ because E_a (forwards) $>$ E_a (backwards), $\therefore k$ ~~will~~ leading to increases faster than $k' \rightarrow \uparrow K_c$

Date

No.

[Faint, mirrored handwriting from the reverse side of the page, including mathematical symbols and text.]

